



**Innovative Circuit
Technology Ltd.**



**MPS Ultra
DC Power System**
INSTRUCTION MANUAL
855-340-030

Models:

ICT-2U4 DC Power System
ICT-2U5 DC Power System
ICT-2U8 DC Power System

 **WARNING**

Risk of serious personal injury or damage to equipment and property!

Always observe the following:

- Install and operate unit in a Restricted Access location, such as an enclosed equipment rack
- Operate the supply from a grounded 3 wire 120Vac or 230/240Vac source (50 or 60Hz) with a branch circuit breaker (see chart on page 13 for breaker rating).

Always observe the following for applications requiring a backup battery:

- Use only a lead-acid battery with rating and capacity appropriate for the model of supply in use
- Use an appropriate dc over-current protection device in line with the back-up battery connection
- Use a disconnect switch or circuit breaker in series with the battery connection, to ensure installation and service is done with the battery de-energised
- Use wire and connectors rated for the maximum load current and size of battery fuse or circuit breaker
- Ensure battery polarity is correct before connecting
- Do not attempt to charge a frozen battery
- Handle batteries with care, never short circuit battery terminals
- Always install batteries in a well ventilated area
- Always consult with battery manufacturer and observe all battery manufacturer recommendations.

 **CAUTION**

Risk of personal injury or damage to equipment! Always observe the following:

- Install in a protected environment, keep sources of moisture away from unit
- Ensure the total power consumption of the load does not exceed the continuous rated capacity of the power supply output
- Do not block air inlet or outlet openings in the unit
- Do not place the power supply directly above or below an exposed battery, due to possible presence of corrosive and/or flammable gasses

Rev 1.2_2019

Copyright © 2018 Innovative Circuit Technology Ltd. All rights reserved. No part of this publication may be reproduced, stored in a retrieval system or transmitted in any form or by any means, electronic, mechanical, photocopying, recording or otherwise, without the prior written consent of Innovative Circuit Technology Ltd.

Contents

INTRODUCTION	4
INSTALLATION	4
Check Unit	5
Configure a System	5
Install Unit	7
OPERATION (Front Panel).....	13
System Status	14
Battery Management Module	15
Load Distribution Module.....	18
Alarm Inputs	19
Alarm History	20
Network Status and Advanced Options.....	20
Password Reset (Front panel).....	21
OPERATION (Network GUI).....	21
Log In to the Unit	21
System.....	22
Power Modules.....	23
Battery Backup Module (BMMD).....	24
Load Distribution Module (LDM).....	28
Alarms.....	32
Communications.....	34
Router Configuration	42
Text Message Notifications	44
Troubleshooting Network Communications.....	45
STATUS INDICATORS AND ALARMS	46
PRODUCT SPECIFICATIONS	48
LIMITED WARRANTY	52

INTRODUCTION

The MPS Ultra is a hot swappable redundant DC power system with Ethernet networked control, advanced battery management, and load distribution options in a factory pre-configured 2RU high rack mount chassis. The ICT MPS Ultra provides N+1 redundancy for power requirements up to 5.6kW. Three power chassis models are preconfigured at the factory to provide fast, easy installation at a site. Every model includes the ICT Intelligent Control Module to provide full TCP/IP remote monitoring and control of all system functions. The 2.8KW and 3.5KW systems include dual 100 Amp battery disconnect breakers, a 150 Amp Low Voltage Disconnect, and configurable fully managed load outputs rated at 20 Amps each. Load outputs can be monitored and power cycled remotely over Ethernet. Advanced battery management functions with the 2.8 and 3.5KW models include battery state of charge, estimated run time remaining, and battery discharge testing.

Power Module Ratings: (Power Modules must be ordered separately)

Module	24V 25A ICT700-24	48V 12A ICT700-48
Output Voltage adjustment range (VDC)	23.0 – 31.0	46.0 – 62.0
Default Output Voltage (VDC)	27.6	55.2
Output Current Limit adjustment range (A)	5 – 25	2.5 – 12.5
Default Current Limit (A) (+5%, -0%)	25.0	12.5

A typical configuration is shown in Figure 1, consisting of an ICT-2U4 power chassis with Intelligent Control Module (ICM), four 700W Power Modules, Battery Management Module (BMMD) with two battery input breakers (battery 1 lower, 2 upper), and Load Distribution (LDM) module (with output breaker 1 to 12). The configuration shown provides a 2.8kW N+1 hot-swappable redundant DC power system with built in battery breakers, LVD contactor, advanced battery management capability, and twelve channels of intelligent remotely controlled power distribution. Every aspect of the system can be monitored and controlled over an Ethernet network.

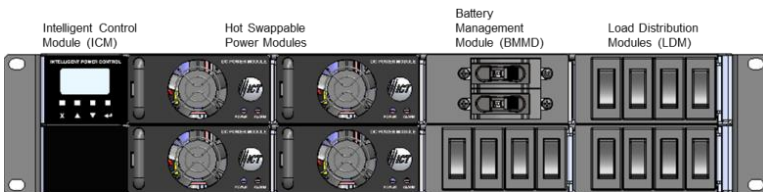

Figure 1. Front View

INSTALLATION

Check Unit

Perform a quick physical check of the unit as it is being taken out of the box to ensure it has not been damaged during shipping. Check that the system configuration matches the version ordered, and that the following chassis accessories were shipped with your unit:

- Instruction Manual
- Two removable 3 pin AC input wire clamp connector plug (in bag)
- Removable 7 pin alarm and temp sensor wire clamp connector (installed)
- Two Removable 3 pin Form-C alarm relay connector (installed)
- Plastic u-shaped cover with two 6-32x1/4" screws for output bus bars (in bag)
- Two bolt/washer/nut sets for connections to the output bus bars (in bag)
- Two bolt/washer/nut sets for connections to the BMMD bus bars (in bag)
- Remote battery temperature sensor (ICT-TMP)
- RJ-11 Parallel Control Cable jumper (ICT-JMP)

System Model Numbers:

Description	Model No. (negative output voltage)	Model No. (positive output voltage)
Intelligent Power Chassis with integrated Control Module and Ethernet communications. Includes dual 100A battery disconnect breakers and 150A Low Voltage Disconnect. 12-position fully managed load distribution outputs Accepts up to four 48 or 24VDC Power Modules for 2.8kW of output power. (Power Modules and load breakers must be ordered separately).	ICT-2U4	ICT-2U4P
Intelligent Power Chassis with integrated Control Module and Ethernet communications. Includes dual 100A battery disconnect breakers and 150A Low Voltage Disconnect. 8-position fully managed load distribution outputs. Accepts up to five 48 or 24VDC Power Modules for 3.5kW of output power.	ICT-2U5	ICT-2U5P
Intelligent Power Chassis with integrated Control Module and Ethernet Communications. Accepts up to eight 48VDC Power Modules for 5.6kW of output power.	ICT-2U8 (positive or negative output, 48VDC only)	

Power Modules: (must be ordered separately)

Description	Model No.
24V 700W Power Module (27.6V, 25A)	ICT700-24PM
48V 700W Power Module (55.2V, 12.5A)	ICT700-48PM

Accessories: (must be ordered separately)

Description	Model No.
5A Circuit Breaker for LDM	ICT-CB5
10A Circuit Breaker for LDM	ICT-CB10
15A Circuit Breaker for LDM	ICT-CB15
25A Circuit Breaker for LDM	ICT-CB25
Blanking Plate for unused power module positions (snap-in)	ICT-BPM
Blanking Plate for unused LDM breaker locations (snap-in)	ICT-BLP

Set Up the Power System:

Ensure you have the correct power chassis unit that is factory configured for Positive or Negative battery voltage (see chassis model numbers above).

- Install the Distribution Module (LDM) breakers in the Load Distribution Module positions by snapping into the four breaker openings, (“On” or “I” facing up, “Off” or “O” down) ensuring the breaker connector tabs securely seat in the LDM breaker sockets. (NOTE: Ensure the correct breaker rating is installed in each location, as breakers can only be removed at a qualified service facility once installed)

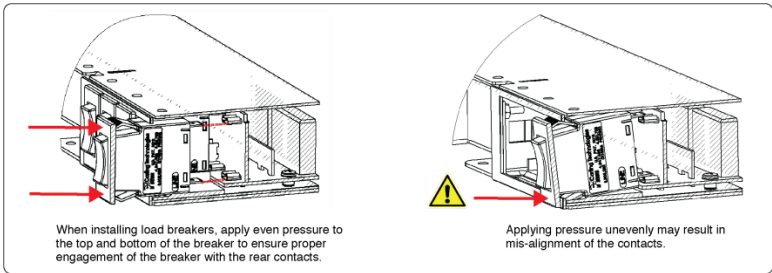

- Snap in a breaker blanking plate (ICT-BLP) in any unused breaker locations on the LDM (if ordered)
- Install Power Modules with the same voltage rating in any remaining open chassis positions. The modules will share the total output load, and may be “hot-swapped” (you can insert or remove a module while the system is powered). Ensure the combined power rating of all the installed power modules exceeds the total requirement of the planned load by at least 700W for true N+1 redundant operation. (N+1 operation requires excess power module capacity to ensure that the load can be fully powered, even if one power module should fail or be removed)

- Carefully align each module with the internal guides and firmly push into the back plane until the module latch clicks into place, and the module is flush with front panel. Note that Power Modules can be easily removed by pressing the release latch located under the module handle while firmly pulling the module from the power chassis (Figure 2). The system may remain powered while swapping modules.
- Snap in blanking plate (ICT-BPM) if ordered into any unused Power Module positions to prevent accidental access to the internal circuitry of the system.



Figure 2: Power Module Release Latch

Install Unit

WARNING

Risk of serious personal injury or damage to equipment and property! Always observe the following!

- When using a backup battery ensure the nominal battery voltage is correct for the model of Power Modules installed, and that the battery positive is connected to the positive (+) terminal and the battery negative is connected to the (-) terminal. **Note that the BAT terminal on the BMMD may be internally tied to the (+) or (-) main output through the LVD contactor, depending on the polarity of the power system used**
- Use an appropriate dc over-current protection device such as a fuse or circuit breaker in line with and near to the battery connection
- Do not tie either power system main output to the BAT terminal on the BMM, as this may short circuit the battery or will bypass the internal LVD circuitry in the BMMD
- Make any earth Ground connection to only a single LOAD or BAT terminal if required. Do not ground both the load and battery as this may bypass the internal LVD circuitry

- Each AC input wiring feed to the MPS Ultra must be protected using an outlet with a branch rated circuit breaker (see chart on page 13 for breaker rating).

Check that the default system output voltage and current limit match the requirements of the battery and the loads to be connected.

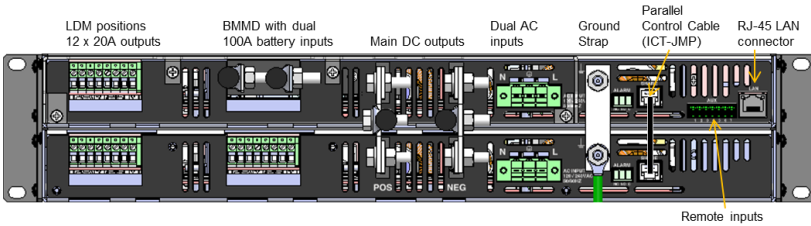

Figure 3. Typical Rear View

Mount the unit in an enclosed standard 19 inch equipment rack or other restricted access location, using rack mounting screws (not supplied). Support the rear of the unit with rack supports or back rail if required.

Make connections to the load using wire and connectors appropriately rated for the maximum output current capability of the unit. The load may be powered three different ways:

Load Connection Point	Features
Directly from main system DC Output Bus Bars	Full current rating of the system is available to operate the load, limited only by the maximum output capability of the combined Power Modules
One of up to twelve LDM Intelligent Output Channel Connector Ports	Channel over current protection with LDM front circuit breaker (1 to 12), individual remote channel on/off control and current monitoring
High Current BMMD Output Bus Bar	Output over current protection with BMMD dual 100A load breakers

- The **LDM** outputs have **Output** and **Return** connection provided for each channel. Verify supply polarity before connecting loads
- Connect a ground bonding wire from the chassis rear ground stud to the rack

Make Sensor and Alarm Connections

- Connect the form-C alarm contact monitoring wiring to the ALARM Output connector if needed, as shown in the following table. The top master

system contacts are flagged for all system alarms while the lower level contacts indicate power module faults only for the lower shelf.

Pin Number	Name	Function
1	NC	Alarm NC (alarm state)
2	NO	Alarm NO (alarm state)
3	Common	Alarm output common

Alarm Output Connector: (use 22-26AWG wire)

- Connect the external Battery Temperature Sensor (ICT-TMP) to the REMOTE input plug on the back panel (see Remote input table, below), to compensate the system output voltage according to the battery temperature. Mount the sensor to the mid-level side of the middle battery in a set using the adhesive backed clip, as shown below. The rate of voltage compensation can be adjusted via the ICM front panel interface, or the WEB GUI in the BMMD Settings section. The default compensation is 0mV/C per cell (no compensation), so this must be set according to the manufacturer's recommendation for your battery to enable charge voltage temperature compensation. Battery temperature is assumed to be 25°C if no sensor is installed.

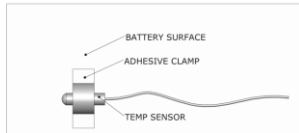

Figure 5: Battery Temperature Sensor Installation

- Install wiring to monitor up to four external voltage free alarm contacts, typically for external sensors such as a door or window switch, smoke detector output, or water detector etc. Enable the alarm inputs and set the contact logic (normally open or contact normally closed) via the WEB GUI, Alarm Settings section once the unit is powered up.

Pin Number	Name	Function
1	Alarm 1	Remote alarm 1 input
2	Alarm 2	Remote alarm 2 input
3	Alarm 3	Remote alarm 3 input
4	Alarm 4	Remote alarm 4 input
5	Alarm Return	Common remote alarm return point
6	Bat Temp	Remote Battery Temperature sensor
7	Bat Temp	Battery temp sensor return

Remote Input Connector: (use 22-26AWG wire)

Make Battery Connections to BMMD

The Battery Management Module (BMMD) provides a convenient and safe way to connect one or two external back-up batteries to the MPS Ultra system. Two

high current hydraulic-magnetic circuit breakers (100A standard) provide over current protection, while an internal 150A LVD contactor will disconnect the battery string(s) should it discharge below a safe level. Both battery strings are routed through the same LVD contactor, so an under voltage condition will disconnect both battery strings. Internal battery current monitoring provides a full suite of remote battery charge monitoring features.

 **WARNING**

Risk of serious personal injury or damage to equipment and property! Always observe the following!

- When connecting a battery ensure the nominal battery voltage is correct for the model of Power Modules installed, and that the battery positive is connected to the positive (+) terminal and the battery negative is connected to the (-) terminal. Note that the BAT terminal on the BMMD may be internally tied to the (+) or (-) system output through the LVD contactor, depending on the polarity of the power system used. **Check polarity of the system before connecting a battery to the BMMD!**
- Only use the Equalize Charge setting for flooded lead-acid batteries in a well ventilated location. **Do not use Equalize Charge on sealed batteries!** Always consult with battery manufacturer and observe all battery manufacturer recommendations.
- Do not tie either of the DC main outputs to the BAT terminal on the BMMD, as this may short circuit the battery or will bypass the internal LVD circuitry in the BMMD
- Make any earth Ground connection to only a single LOAD or BAT terminal if required. Do not ground both the load and battery as this may bypass the internal LVD circuitry
- Use wire and connectors appropriately rated for the highest possible system current when making connections to the battery, BMMD, and DC main outputs

Note: Check that the default system output voltage and current limit match the requirements of the battery and the loads to be connected. Adjust the system Output Voltage and Current Limit (see System Settings section) to match the combined battery and system load requirements before making final connections, if required. If using dual battery strings, **use only identically rated battery strings** to ensure equal charging of each battery set.

Verify the polarity of BMMD installed in your MPS Ultra system by noting the label under the rear BAT bus bar input. (“**BAT +**” indicates a positive battery voltage system with the LVD contactor and battery breaker internally connecting this terminal to the system “**+**” output, while “**BAT -**” indicates a negative battery voltage system, with the LVD contactor and battery breaker internally connecting this terminal to the system “**-**” output).

Use wire and connectors appropriately rated for the highest possible system current when making connections to the battery, BMMD, and DC main outputs. Connect the battery hot lead (see comment on polarity, above) to the BMMD BAT bus bar, and the battery Return lead to the main system output bus bar of the corresponding polarity.

A **Negative Voltage** system will have the battery (-) tied to the BMMD terminal, with the battery (+) tied to the main POS output busbar (Figure 6). A **Positive Voltage** system will have the battery (+) tied to the BMMD terminal, with the battery (-) tied to the main NEG output busbar (Figure 7).

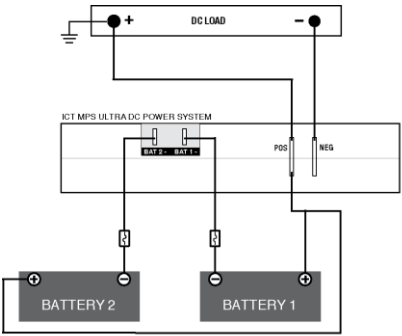

Figure 6: Negative Voltage (Positive Ground) Systems

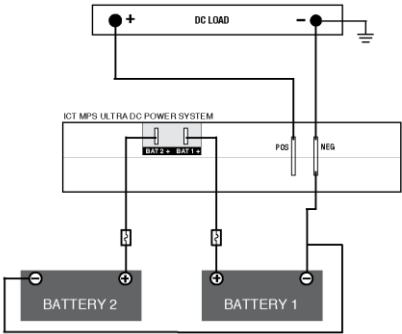

Figure 7: Positive Voltage (Negative Ground) Systems

Make Load Connections to LDM

The Load Distribution Module (LDM) provides up to 12 remotely monitored and controlled outputs, with front panel over current protection provided by hydraulic-magnetic circuit breakers. (See page 6 for breaker installation instructions).

System Voltage	LDM Output Capacity
48 or 24VDC	UP to 12 x 20A cont. output (25A pk)

⚠ CAUTION:

Ensure that the current draw on the LDM outputs does not exceed the output capacity of the Power Modules.

Locate the outputs on the LDM back panel connector block. Note that the internal channel relay, current sensor and circuit breaker are in the Hot or output line, with Voltage polarity depending on the configuration of the system. (Each output = NEG V, for -48V or -24V power systems; each output = POS V, for +24 or +48V configured systems).

Verify the polarity of your MPS Ultra, and then connect up to twelve external loads using appropriately rated wire inserted and torqued in the cage-clamp output connector pairs on the LDM module back panel.

Finalize all System Wiring

Make a Network Connection: Connect a 10/100Base-T Ethernet cable to the RJ45 LAN port on the back panel to allow for remote monitoring and control of the Power System (see the Network Monitoring and Control section for information on configuring and using the built in Web-GUI, e-mail, and SNMP functions).

Install the provided Parallel Control Cable (ICT-JMP) between the two Share ports on the rear (figure 8).

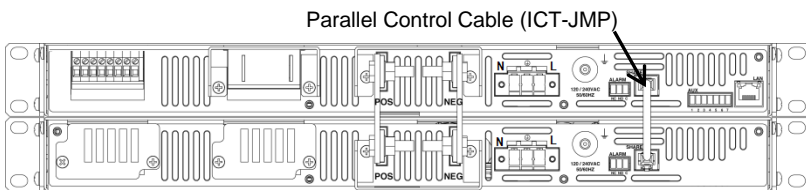

Figure 8. Install Parallel Control Cable

Check that all connections to the power supply are correct and tight; re-install the plastic bus bar cover(s) using the screws provided.

Connect the AC power source: De-energise the AC source by switching off its circuit breaker. Create two power cables using 3 conductor cord rated for the maximum input current of the unit by stripping and terminating the three wires in the Line, Neutral, and Ground terminals of the removable AC input connector provided with the unit (AC line labeled “L”, neutral labeled “N” and safety ground to the middle pin).

Plug the AC connectors into the dual AC inputs on the power system back panel, and tighten the captive retaining screws. **IMPORTANT:** Both AC input feeds must be used.

Wire or plug the source end of the cords to the de-energized AC supply (120V 30A, or 230V 16A, 50 or 60Hz).

Add an external breaker to the AC input to protect the Ultra MPS from current inrush as shown in the table below:

Number of Power Modules installed in a single shelf	Recommended Breaker Rating (per shelf)	
	100-120VAC Input	200-240VAC Input
Two Power Modules	25A	15A
Three Power Modules	40A	20A
Four Power Modules	40A	25A

Example: 3.5KW Ultra MPS at 240VAC input having 2 modules on the top shelf and 3 modules in the bottom shelf will require a 15A breaker on the top shelf AC input and a 20A breaker on the bottom shelf AC input.

OPERATION (Front Panel)

Switch on the external AC power source circuit breaker, and check that the green POWER LED is lit on each Power Module, and that the ICM front graphic display is lit.

Your ICT MPS Ultra will start up and operate at the factory default settings when AC power is connected, generally requiring no other set up or adjustment for basic operation.

Use the front graphic display and four interface buttons on the Intelligent Control Module (ICM) to monitor the supply operation and to make changes to settings such as output voltage, current limit, and battery Low Voltage disconnect points. (The display will go off after approximately 60 minutes of no use, and can be re-activated by momentarily pressing any of the front control buttons.)



Figure 9: ICM Front Control Interface – System Status Screen

The ICM Interface panel consists of the following elements:

System Display screen: Default System Status screen shown in Fig 9 displays the system output voltage, the AC input voltage, and the total output current. (Numerically, and with a graphical indication of relative magnitude of system output current level) The screen will also show any active alarm conditions, and

the current reading will flash to indicate when the unit is operating at its current limit.

Up/Down ▲ ▼ Buttons: Use to scroll through display screens, and to adjust selected settings

Enter ◀ Button: Press to select a screen for adjustment, or to enter a new value after adjustment

Back X Button: Press to return to the previous higher level menu item, or to exit from a setting without making any change

See the complete menu structure in the following diagram. Navigate through the various screens using the up and down arrows, the back button, and the Enter button.

Note that output voltage and current limit settings apply to the combined output of all installed power modules. The ICM treats the combined modules as a single high power supply. Adjust the system output Voltage and Current Limit (see System Settings section) to match the battery type and system load requirements if required.

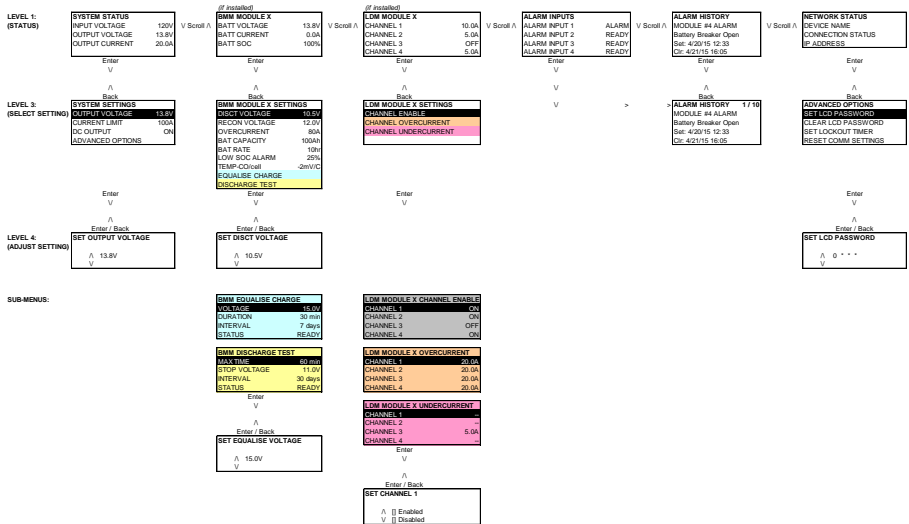

Figure 10: ICM Menu Structure

System Status

The main system status screen will show the most current operating conditions for the unit, primarily the Input Voltage (Vac), the Output Voltage (Vdc), and the

total Output Current (Adc)(Flashing when at the set current limit). Other information will be shown depending on the operating state of the unit:

- A small thermometer symbol to indicate that the remote temperature sensor is installed and may be compensating the output voltage
- A bargraph indicating relative output current
- Indication that the output has been Disabled (off)
- Indication that a battery discharge test is in process

System Settings: The output voltage and output current limit settings come with factory default values that should be adjusted to match your actual system and battery float voltage requirements, as shown below:

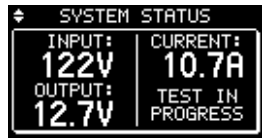
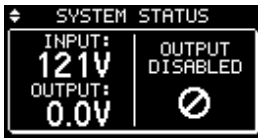
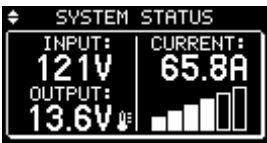

Press Enter to move to the System Settings

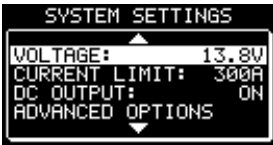

Scroll to highlight the parameter to change

- System Voltage
- Max total Output Current Limit
- Output Enable ON/OFF (default = ON)
- Advanced Options (Set screen Password, Clear Password, Set screen Lockout timer, Reset Comm settings to defaults)



Press Enter to select

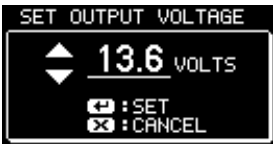

Scroll to adjust parameter (Output V shown), press Enter to set value. Press Back **X** to return to System Settings Screen



Alarms will be shown as they occur, press Back **X** button to return to the Status screen, press Enter for Alarm History info

Once the output voltage and current limit values are configured to suit the connected battery and loads, switch on the optional BMM battery breaker 1, and battery breaker 2 (if installed) to connect the backup battery string(s) to the

system. Switch on the LDM output breakers 1 to 4 (if installed) to energise any loads connected to the Distribution Module outputs.

Battery Management Module

The Battery Management Module (BMMD) provides a convenient and safe way to connect 1 or 2 matching battery strings to the MPS Ultra system. Dual high current hydraulic-magnetic circuit breakers provide over current protection, while an internal LVD contactor will disconnect the battery should it discharge below a safe level. Internal battery current monitoring provides a full suite of remote battery charge monitoring features.

The BMMD status screen indicates the Battery Voltage (Vdc), the combined Battery Current (+ Adc for charging, -Adc for discharging), the approximate battery State of Charge (SOC %), and a bar graph showing relative magnitude of the total battery current. A battery graphic marked with **X** indicates the battery is disconnected, replacing the SOC reading, as shown below.

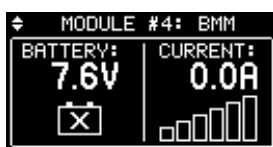
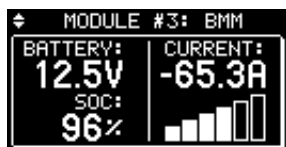

BMM Status Screen with Battery-Disconnected icon

The SOC% is estimated by counting the Ah flowing into and out of the battery while knowing the nominal rated capacity of the battery (See **BMMD Settings** Screen below to adjust the battery Ah capacity) The system resets the SOC to 100% whenever it detects that the battery is at the rated Float Voltage with minimal charge current for at least 24hr.

BMMD Settings: The module comes with factory default settings loaded that should be configured to match the actual battery used in the system.

Adjust the **LVD** contactor **Disconnect** and **Reconnect Voltage** according to the battery manufacturer's recommendations.

Set the **Battery Overcurrent** Alarm level (Amps) to trigger an Alarm for excessive discharge current or charge current. (set to 0A to disable this alarm)

Configure the combined **Battery Capacity** (Ahr) so the system can estimate the total battery SOC%. Also set the **Battery Rate** (hrs) used in the battery specification to determine the battery capacity. (Usually will be 20hr or 10hr rate) Note that series connected batteries have the Ahr capacity of a single battery, while connecting batteries in parallel increases the total Ahr capacity.

Set the **Low SOC Alarm (%)** if desired, to raise an alarm when the battery is nearly discharged

Ensure the Battery temperature sensor (ICT-TMP) is installed and connected to the battery case (see **Make sensor and Alarm Connections** in the Installation section) for optimal Lead-Acid battery charging and best battery life. Set the **Temperature Compensation/°C** level per battery cell to match the recommendation of the battery manufacturer. (-4mV/°C per cell typical)

Configure the **Battery Equalize Charge** voltage, duration, and automatic repeat interval if desired when using flooded lead-acid type batteries only. The system will step up the output voltage to the Equalize Voltage for the Equalize Duration time whenever the Equalize Status is set to Enable, or automatically each interval time (days) when an Interval is set (default is 0, or off), once the battery is fully charged.

 **WARNING**

Use the Equalize Charge setting for flooded lead-acid batteries in a well ventilated location only. **Do not use Equalize Charge on sealed batteries!**

Configure the **Battery Discharge Test** to either manually or automatically check on the battery's ability to power the system for a set duration. Set Max Discharge Time, minimum Stop Voltage, and the automatic repeat Interval if desired. Each time the test is run the output voltage from the power modules will be reduced so that the external battery will power the system load until either the Max Discharge Time limit or the Stop Voltage is hit. A **Discharge Test Complete** notification (on the front display and with an e-mail if messaging is configured via the Network GUI) will indicate a **Test Failure** if the Stop Voltage is hit before the Max Time limit, as the battery was not able to power the load for the desired duration. Set the test **Interval** (days) to have the system initiate a discharge test every interval, once the battery reaches 100% SOC.

You may alternatively manually initiate a Battery Discharge Test of a fully charged battery by changing the discharge test Status parameter to **Enabled**.

BMMD status screen shown below:

Dual Battery String BMMD
Status Screen

- Battery 1 Voltage
- Battery 2 Voltage
- Combined Battery Current
- Combined SOC%

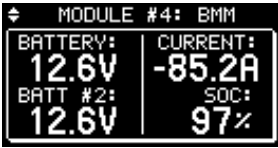

Press Enter to move from the Status screen to the BMM Settings screen

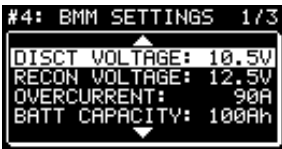



Scroll to highlight parameter to change

- LVD Disconnect V
- LVD Reconnect V
- Over Current Alarm level
- Battery Capacity (Ahr) rating
- Battery discharge rate (hrs) used for capacity spec. (typically either 10 or 20hrs)
- Low SOC Alarm (default 25% SOC)
- V Temp-co/cell (default = 0, typ = -4mV/°C)
- Equalize Charge settings
- Discharge Test settings

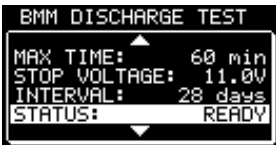

Press Enter to select parameter to adjust



Scroll to choose parameter in selected sub-menu. Press Enter  to select that item for adjustment



A notification will automatically appear indicating the results of a Discharge Test at completion of the test

Load Distribution Module

The Load Distribution Module (LDM) provides a convenient way to include up to twelve channels of remotely managed DC power distribution within the MPS Ultra system. Front panel mounted hydraulic-magnetic circuit breakers give over current protection for each channel, while independent current monitoring and on-off control allow for complete remote management of the connected loads. (Note that removal of the LDM circuit breakers must be done at the factory; ensure you are installing the correctly rated parts in the correct location prior to snapping in place).

The LDM Status screen shows the output current for each of the four outputs, plus indicates if a breaker is OPEN, and if an output has been switched OFF.

LDM Settings: Each output on the LDM may be forced ON or OFF by using the **OUTPUT CONTROL** function.

Set a load current level alarm by adjusting the output overcurrent, or output undercurrent threshold.



LDM Status Screen (OFF = channel set to off, OPEN = channel breaker tripped)



Press Enter to move from the Status screen to the LDM Settings screen

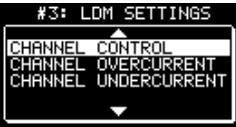

Scroll to choose parameter or sub-menu. Press Enter  to select that item for adjustment



Press Enter to select setting to be changed



Scroll to choose Output to be changed (On/Off control shown)



Scroll to change setting. Press Enter  to set, press Back **X** button to exit without changing

Alarm Inputs

The Alarm Inputs Status screen displays the current status of the four alarm inputs provided on a power system equipped with the Intelligent Control Module. Use these inputs to monitor voltage free external contact closures such as door sensors, smoke alarm outputs or a water sensor.

The alarm input Status screen shows the state of these contacts, changing from OK to ALARM when a contact activates. Configure the logic of the external contact type selecting Normally Open (NO) or Normally Closed (NC) to activate the alarm inputs using the Network GUI interface. The factory default setting has the alarm inputs disabled; you must select a contact type for each input to enable it.



Alarm Input Status screen



Press Enter or scroll to see the Alarm History log

Alarm History

Scroll through the Alarm History screens to see the log of the 20 most recent alarm events. These alarms may have been raised by any module experiencing an alarm, or by one of the four external Alarm Inputs being triggered.



Scroll through the history screens to see the 20 most recent Alarm events. Shows the Module that raised the alarm, date, and time when set, and cleared

Note: The system date and time are normally set by the network. These may be manually set, see Network GUI Operation, Communication Basic Setup section.

Network Status and Advanced Options

Scroll to the Network Status Screen to check the network connectivity, **IP address** of the system, and the assigned MAC address. Access the Advanced Options screen by pressing the Enter button when on the Network Status screen to set or clear a 4 digit **LCD Password** (to lock out the ICM Display adjustments after the LOCKOUT TIMER has expired), set the display **Lockout Timer** duration (0 to 60minutes), or **Reset Comm Settings** (sets GUI password, Communication settings, and IP address to the factory defaults).

Note: You will be prompted to enter the LCD PASSWORD once it is activated, when attempting to change any of the power system settings.

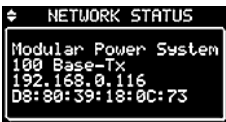

Network Status Screen





Press Enter to move to the Advanced Options screen





Scroll to setting to be changed



Scroll to adjust setting (Display Password setting shown) Press Enter  to save each setting, or Back  to exit with no change

Password Reset (Front panel)

Always record the display password when set, as it must be entered to change any supply settings. To clear the display password in cases where it is lost, switch off the AC power to the unit, then simultaneously press the ENTER  and BACK  buttons for more than 15s while restoring the AC power. A new password will then have to be re-entered as shown above if password protection is required.

Reset the network GUI password back to the factory default (user: admin, no pw) by selecting **RESET COMM SETTINGS** in the Network Status front panel display menu shown above.

OPERATION (Network GUI)

Connect to your Intelligent Power System via the Ethernet for full access to all system settings, status, and alarm conditions. Each MPS Ultra is equipped with a built in Web server that can be accessed via any standard web browser on a network connected computer or phone. No additional software is required on your device.

Log In to the Unit

1) Connect to the MPS Ultra by entering the IP address of the unit in the location/address field of your browser as shown:

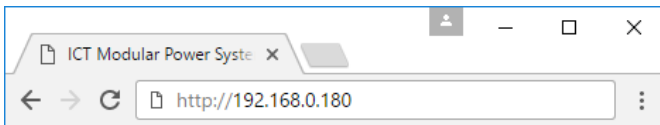

The default IP address of the unit is **192.168.0.180**, but any MPS connected to a network with a DHCP server will be assigned a different IP address automatically. To find the assigned address use the front graphic display interface on the power system, and navigate to the NETWORK STATUS screen. Note the assigned IP address displayed, and use this in your browser address field to access the unit remotely.

You can also find the IP address of any ICT unit on a local network by running the **ICT IP Address Discovery tool**, after installing it on your Windows computer connected to the same network (tool available for download from <http://www.ict-power.com/tools-utilities/>)

2) You will be prompted for a user name and password to log into the MPS Ultra system's built in server. The default user name is **admin**, and no password is required as the factory default.

To log out of the ICT MPS Ultra GUI close your browser session.

System

Once successfully logged in the **System** page will be shown in your browser:

The screenshot displays the 'System Status' page of the ICT MPS Ultra. The page is titled 'Modular Power System' and includes the following information:

- System Information:** Modular Power Series 48V, IP Address: 192.168.0.180, Firmware: v1.03
- DC Output:** Output Status: Enabled, Output Voltage: 54.9 VDC, Total System Current: 0.2 A
- AC Mains:** Input Voltage: 122 VAC
- System Alarms:** Form C Alarm: OK, Power Module #1: OK, Power Module #2: OK, Power Module #5: OK, Power Module #6: OK, Power Module #7: OK
- Module #3 : Battery Management:** Battery Voltage: -, Battery Current: 0.0 A, Battery Temperature: -, Net Ah Count: 0 Ah, Run-time Remaining: -, Battery State of Charge: -, Battery 2 Voltage: -, Alarm Status: OK
- Module #4 : Load Distribution:** Output #1: 0.0 A, Output #2: 0.0 A, Output #3: 0.0 A, Output #4: 0.0 A, Alarm Status: OK
- Module #8 : Load Distribution:** Output #1: 0.0 A, Output #2: 0.0 A, Output #3: 0.0 A, Output #4: 0.0 A, Alarm Status: OK

Copyright © 2018 Innovative Circuit Technology Ltd.

The **STATUS** tab provides a snap-shot of the operating status of the unit, showing the output voltage and current, the AC input voltage, the optional Battery Management Module parameters, the state and loading on the four optional Load Distribution module outputs, and the Alarm states of the internal alarm relay, and the four remote alarm inputs.

Click on the **SETTINGS & CONTROL** tab, to access the following functions:

- Use the **ON/OFF** buttons to remotely disable the system output by shutting off all power modules

- Use the **Auto Re-start** button to momentarily shut off the main output, and then restart automatically after a time delay (set in the **Auto-Restart Delay** field). This feature can be used to remotely force connected equipment to re-boot.
- Set the system **Output Voltage** (to match the float voltage requirement for your external battery)
- Set the system output **Current Limit**, to limit the total current that can be drawn by all the external loads

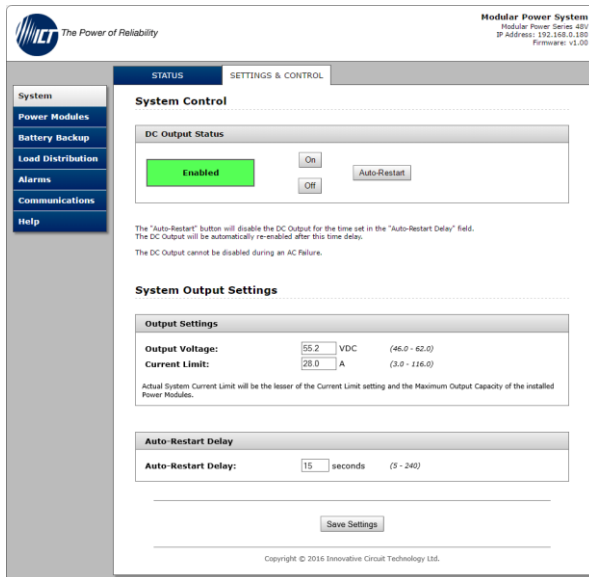

Power Modules

Use this page to see the current status of all installed power modules in the system. Use the **System** page **SETTINGS & CONTROL** tab to make any changes to the output voltage and current limit of the combined modules. The combined maximum output capacity of all active power modules is shown here.

Modular Power System
 Module Firm: Series: 487
 IP Address: 192.168.0.180
 Firmware: v1.53

STATUS

Power Modules - Status

Module #	Status
1	OK
2	OK
3	Offline
4	Offline
5	OK
6	OK
7	OK
8	OK

Module Status

Module:	Type:	Status:
#1:	Power Module	OK
#2:	Power Module	OK
#5:	Power Module	OK
#6:	Power Module	OK
#7:	Power Module	OK

Power Module Capacity

Online Power Module Capacity: 70.0 A

[Refresh List](#)

Copyright © 2018 Innovative Circuit Technology Ltd.

Battery Backup (BMMD)

Select the **Battery Backup** page (**STATUS** tab) to observe the status of the external battery (which may consist of 2 battery strings). You may check battery string voltage, combined current (+ is charging, - is discharging), temperature (if ICT-TMP probe installed), Net Ah count (approximate Ah discharged from the battery, where 0Ah denotes full charge), the estimated run time remaining at the current load when in back-up mode, approximate battery state of charge in %, and the LVD threshold voltage settings.

Modular Power System
 Modular Power Series: 487
 IP Address: 192.168.0.180
 Firmware: v1.53

STATUS **SETTINGS & CONTROL**

Battery Backup - Status

Module #	Status
1	Offline
2	Offline
3	OK
4	Offline
5	Offline
6	Offline
7	Offline
8	Offline

Module Status

Module:	Type:	Status:
#3:	Battery Management	OK

Module #3 : Battery Management

Battery Voltage: -
 Battery Current: 0.0 A
 Battery Temperature: -
 Net Ah Count: 0 Ah
 Run-time Remaining: -
 Battery State of Charge: -
 Battery 2 Voltage: -
 LVD Disconnect Voltage: 42.0 VDC
 LVD Reconnect Voltage: 50.0 VDC
 LVD Status: Open
 Alarm Status: OK

[Refresh List](#)

Copyright © 2018 Innovative Circuit Technology Ltd.

Click on the **SETTINGS & CONTROL** tab to configure all battery related settings. Click on the **Save Settings** button at the bottom of the page to store your changes.

Output Voltage Control, Temperature Coefficient/Cell:

Make adjustments to the Battery voltage Temperature Coefficient/cell to optimize the automatic control of the battery charging voltage, to keep your battery in a good state of health.

Adjust this setting to match the battery manufacturers recommended compensation value in $-mV/°C$ per cell. This value will typically be $-4mV/°C$ for a flooded lead-acid battery (i.e. will compensate output voltage $-24mV/°C$ for a 6 cell 12V battery) to help ensure the battery is fully charged in cold locations, and

is not overcharged when warm. Note that the system must have the battery temperature sensor (ICT-TMP) installed on the battery for this setting to have an effect. (default setting is 0mV, assumes 25°C operation)

Equalize Charge Settings

Set up manual or automatic equalize charge cycles for flooded lead-acid batteries.



WARNING

Risk of serious personal injury or damage to equipment and property! Always observe the following: Equalize charging is intended for Flooded Lead-Acid batteries only, and may produce higher than normal levels of hydrogen gas. Ensure the battery compartment is well ventilated to avoid any risk of explosion! Always consult with battery manufacturer and observe all battery manufacturer recommendations.

Equalize Voltage: Adjust this setting to the battery manufacturer’s recommended value for an Equalize (or Boost) charge (for flooded lead-acid batteries only). A regular high voltage Equalize charge will help prevent stratification of the electrolyte in your battery, and can help extend its life.

Equalize Duration: Set the duration time (10-240 minutes) for the equalize charge voltage to be applied (as recommended for your battery).

Equalize Interval: Set the Equalize Charge Interval (0 – 180 days) so the system will perform an automatic Equalize charge once every interval time has elapsed. Set this time to 0 (default) to disable the automatic equalize charge.

Note that an Equalize Charge can only be initiated when the battery is fully charged. Press the Manual Equalize Charge button to manually initiate an equalize charge for the set Duration time once the battery is fully charged. (System will state that Manual Equalize Charge is Not Ready, if battery is not yet fully charged)

The days since the last equalize charge and the duration of that charge is noted here, along with the days remaining until the next automatic equalize charge. This information is to help track where the system is within the automatic charge cycle.

Configure Battery

Set the rated **Battery Capacity** in Ah (50 to 1000Ah) of the total battery pack connected to the power system, and the discharge **RATE** (in hr) used by the battery manufacturer to determine the battery capacity. Normally the 10 or

20hr rate is used. The system will use this information to help determine the battery state of charge, and remaining battery capacity when in use. Note that connecting two batteries in parallel will double the total Ah capacity, while connecting batteries in series will increase the voltage with no change to the Ah capacity.

LVD Settings

Set the battery Low Voltage **Disconnect Voltage** threshold to a level that will protect the battery from excessive discharge. (default is 10.5/21/42V) The LVD contactor will open when the battery discharges to this level for at least 3s.

Set the **Reconnect Voltage** to a level at least 1.5V more than the disconnect voltage to prevent the LVD contactor repeatedly cycling on and off. This setting will be used when charging the battery from an external dc source (such as a solar system), otherwise once AC power returns the LVD contactor will automatically close so that the power modules can charge the battery directly.

Battery Over-Current Alarm

Set the system output **Over-Current Threshold** to receive an alarm notification when the output current exceeds a set over-current level. Set the threshold to 0A to disable this alarm. (default setting)

Battery Low SOC Alarm

Set the **SOC Threshold** to receive an alarm notification when the battery state of charge falls below the set level. Set the threshold to 0A to disable this alarm. (default setting)

Alarm Reporting

Configure how you would like to be notified of the BMMD alarms. Select the **Activate Form-C Contact** check box (default) to have the back panel alarm contacts change state for an alarm condition, and/or select the **Send E-mail** check box to have an alarm e-mail sent to the e-mail addresses set up on the communications page.

Battery Discharge Test

Configure the Battery Discharge Test settings in this section, so that you may either manually or automatically perform a partial discharge test to gauge the relative capacity of the external battery. You should generally limit the depth of discharge to no more than 50% of the nominal battery capacity to avoid stressing the battery due to a deep discharge.

NOTE:

This test must only be done when AC power will be present during the test and for adequate time after the test to allow for a full re-charging of the battery.

Otherwise the battery may not have sufficient remaining capacity to power the load during an AC power outage.

Set **Max Discharge Time**, minimum **Discharge Voltage Limit**, and the automatic **Discharge Test Interval** if desired. Each time the test is run the output voltage from the power modules will be reduced so that the external battery will power the system load until either the **Max Discharge Time** limit or the **Discharge Voltage Limit** is hit. A **Discharge Test Complete** notification (on the front display and with an e-mail if messaging is configured via the Network GUI) indicates the battery is able to power the connected load for the set test duration while maintaining its voltage above the Discharge Voltage Limit. The system will indicate a **Discharge Test Failure** if the minimum Voltage Limit is hit before the Max Discharge Time limit, as the battery was not able to power the load for the desired duration.

Set the **Discharge Test Interval** (days) to have the system automatically initiate a discharge test every interval, once the battery reaches 100% SOC. Set this interval to 0 days to disable the automatic Discharge Test. (default setting)

You may alternatively manually initiate a Battery Discharge Test of a fully charged battery by changing the **Manual Discharge Test** parameter to **Enabled**. (This test parameter will show that the discharge test is **Not Ready** if the battery SOC is less than 100%)

Observe the saved information regarding the most recent discharge test shown here, with fields for days since the **Last Battery Discharge Test**, **Status** (Pass or Fail), **Discharge Time**, **End Voltage** at the completion of the test, and the **Amp Hours Discharged** during the test. The scheduled days until the next automatically repeating test will also be shown if this feature has been enabled.

Load Distribution (LDM)

Select the **Load Distribution** page (**STATUS** tab) to observe the status and load current of the controlled outputs on the LDM module.

ICT The Power of Reliability

Modular Power System
 Modular Power Series 88V
 IP Address: 192.168.0.180
 Firmware: v1.03

STATUS **MODULE #4 SETTINGS** MODULE #8 SETTINGS

Load Distribution - Status

1 2 3 **4**

5 6 7 **8**

Module Status

Module:	Type:	Status:
#4:	Load Distribution	OK
#8:	Load Distribution	OK

Module #4 : Load Distribution

Output #1:	0.0 A
Output #2:	0.0 A
Output #3:	0.0 A
Output #4:	0.0 A
Alarm Status:	OK

Module #8 : Load Distribution

Output #1:	0.0 A
Output #2:	0.0 A
Output #3:	0.0 A
Output #4:	0.0 A
Alarm Status:	OK

[Refresh List](#)

Copyright © 2018 Innovative Circuit Technology Ltd.

Click on one of the **MODULE SETTINGS** tabs to configure the settings for each output channel on that Load Distribution Module.

STATUS
MODULE #4 SETTINGS
MODULE #8 SETTINGS

System

Power Modules

Battery Backup

Load Distribution

Alarms

Communications

Help

Module #4 - Control

Module Output Control

Output #1:

Output #2:

Output #3:

Output #4:

If Power Cycling is enabled in Module Output Configuration settings, the "Off" button will be replaced with a "Cycle" button.

Master Output Control

Module Setup (Click "Save Settings" when finished)

Power-On Sequencing / Power Cycling

Delay Time: second(s) (0 - 60)

This sets the delay time before energising each output when the System DC Output is turned on, or when an output is power cycled.

Alarm Reporting

When an alarm is triggered on this module,

Activate Alarm Form C Contact:

Send E-mail:

Module Output Configuration (Click "Save Settings" when finished)

Select an Output to edit

#1:
 #2:

#3:
 #4:

Output #1 Settings

Output Label:

Output State after Power Loss:

Ignore Circuit Breaker Status:

Enable Power Cycling:

If Power Cycling is enabled, "Delay Time" must be set above.

Module Output Control:

Click on the **Output #1 to #4 On or Off** button to close or open the relay on that output channel. Click on the Master Output Control **All Outputs On**, or **All Outputs Off** button to open or close the relays on all four output channels simultaneously. (All outputs are enabled as the factory default setting)

Module Setup:

Use this section to set the **Power Cycle Delay** time, which will be used as the delay time (in seconds) before energising an output, for each output that has power cycling enabled. (See Output Configuration below)

Select the Alarm actions to be taken for the LDM **Alarm Reporting** - chose to activate the back panel Form-C alarm contact output and/or send an alarm e-mail to the address' chosen on the e-mail setup page by ticking the appropriate boxes.

Module Output Configuration:

Select the output to be edited in the **Select an Output to Edit** box. Make any required changes, and then click on the **Save Settings** button at the bottom of the page to save any edits.

Output Settings

Output Label: Enter a descriptive label for the selected output channel if desired.

Output State After Power Loss: Sets the state for the output after the LDM loses all input power, then recovers. Select one of the following:

- **Restore last State:** Will return the output contactor to the state prior to the reset event (default)
- **Enable Output:** Will enable the output contactor, regardless of its previous state
- **Disable Output:** Will disable the output contactor, regardless of its previous state

Ignore Circuit Breaker Status: Will mask the circuit breaker open circuit detection, to prevent false alarms on an unused channel.

Enable Power Cycling: Check this box to enable output power cycling for the selected output, so that the output will automatically be re-enabled after the **Power Cycle Delay** time whenever the output is disabled using the **Output Off** button on the **Settings and Control** page, or when the **Network Watchdog** is triggered. This feature is useful for remotely resetting power to a router or other hardware required for the network connectivity of the panel.

Note: The **Power Cycle Delay** time must be set with duration long enough for the connected network hardware to fully reset for this function to be effective. Multiple outputs that are disabled using Power Cycling will be re-enabled in sequence from Output 1 to output 4.

Output Load Shedding

Enable Load Shedding: Check this box to disable this output when the bus voltage drops below the load-shedding threshold for at least 30s. This feature can be used to disconnect less critical loads to preserve back-up battery power as the battery voltage drops when the AC power has failed.

Load-Shedding Threshold: Enter the voltage level at which the selected output will be disconnected.

Auto Recovery Threshold: Enter the voltage level at which the selected output will automatically be reconnected. This value must be at least 0.5V above the **Load-Shedding Threshold** voltage.

Load-Shedding Auto Recovery: Check this box to allow the output to be automatically reconnected when the bus voltage is above the **Auto Recovery Threshold** for at least 60s. The output must be manually re-enabled using the **Output ON** button if the **Auto Recovery** function is not enabled.

Output Over(Under)-Current Alarm

Over-Current Threshold: Enter the over-current level. Output current above this level for at least 5s will trigger the Over-Current Alarm. Disable this alarm by setting the threshold to 0A (default).

Under-Current Threshold: Enter the under-current level. Output current below this level for at least 5s will trigger the Under-Current Alarm. Disable this alarm by setting the threshold to 0A (default).

Click the Save Settings button to save the configuration for that channel, and then repeat the setup process for each of the 4 output channels to be used.

Alarms

Click on the **Alarms** page to check the status and alarm history on the **STATUS** tab.

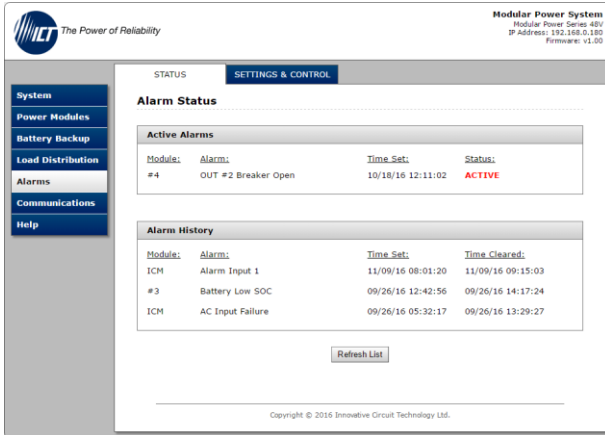

Click on the **SETTINGS & CONTROL** tab to set up the four remote alarm monitoring inputs. Give each input a meaningful name to suit the installation (these will be used for e-mailed alarm messages), and select a **Contact Type** of either Normally Open (NO) or Normally Closed (NC) for each device to be monitored. Set alarm **Contact Type** to Not Used for all unused alarm input channels (default setting).

Select the action to be taken in the event of an alarm condition for each input, either activate the local Form-C contact alarm output relay on the MPS system, or send an alarm e-mail to the addresses set up in the Communications section.

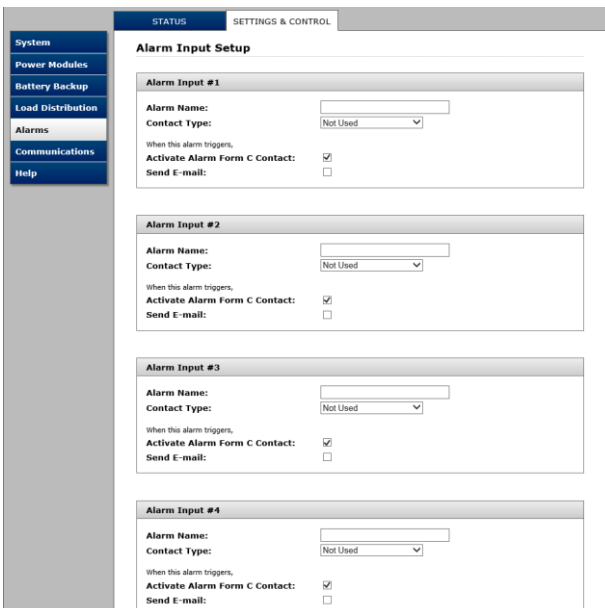

Communications

Select the **Communications** page tab to configure the Basic system parameters, Network settings, E-mail settings, User setup, and Maintenance functions. Click the Save Settings button at the bottom of each page to enable any changes you have made.

Select the **BASIC SETUP** tab to configure the device name, set the date and time and enable the watchdog timer and data logging features.

Power System Device Info:

Enter a **Device Name** for the system (used in all email messages), and view the Model and hardware version.

Date and Time Settings:

Check the system internal clock settings here, and select the tick box to **Synchronize with NTP Server** (default), then Enter an **NTP Server** address (i.e. time.nist.gov) to automatically load network time. You may choose to **Set Time Manually** by selecting the tick box, and then enter the correct **Date** and **Time**.

Network Watchdog:

Enable the Network Watchdog to cycle power to an external device on loss of communications by selecting the **Watchdog Enabled** tick box. Set a **Primary** and **Secondary IP Address** for the unit to ping to determine the network is functioning, and then enter a **Watchdog Timeout** (1-60 minutes) to set how long the system will wait with no ping response from either IP address before initiating a reset. Choose a **Reset Target** (either **LDM Channel Outputs**, or the main **System Output**) which will then be reset for the power cycling delay time to re-boot any connected devices. Selecting "LDM Channel Outputs" as the Reset Target, will cause all Load Distribution Module channels with the "Enable Power Cycling" option selected to be cycled when the Network Watchdog times out. When selecting to reset the main "System Output", set the Auto Restart Delay time on the System page to define how long the system will be off when the Watchdog timeout is triggered.

Data Logging:

Enable **Data Logging** to keep a running record of the all the key system parameters and alarms, recorded once per minute for up to the last 30 days. Click on the **Download Log (CSV)** button to store the CSV format log file on your computer for further analysis. Click the **Clear Log Now** tick box to clear the system onboard data log and start a fresh log record.

The screenshot shows the 'NETWORK SETUP' page with the following sections:

- Power System Device Info:** Device Name: Modular Power System; Model: ICT-IPS; Hardware: Version 01.
- Date and Time Settings:** Current System Time: 11/29/16 20:57:44; Synchronize with NTP Server: ; NTP Server: pool.ntp.org; Time Zone: GMT; Set Time Manually: ; Date (MM/DD/YY): 11 / 29 / 16; Time (HH:MM:SS): 20 : 57 : 44.
- Network Watchdog:** Watchdog Enabled: ; Primary IP Address: ; Secondary IP Address: ; Watchdog Timeout: 10 minute(s) (1 - 60); Reset Target: (LDM Channel Outputs).
- Data Logging:** Data Logging: Enabled; Log Start Date: 10/30/16 12:30:10; Clear Log Now: ; Download Log (CSV):

Configure network settings on the **NETWORK SETUP** page.



NOTE:

Saving any changes to the network settings will cause the ICM to re-start, causing momentary loss of communications

Network:

MAC Address: Displays the MAC address assigned to the panel. It is also shown on line four of the LCD Network Status screen.

Enable DHCP: Turn on this setting if your network uses a DHCP server to automatically assign IP addresses. (Enabled as default setting). To manually assign a static IP address to the unit uncheck this box, then set the following parameters.

IP Address: Specify a unique IP address for the unit.

Subnet Mask: Specify the mask for the subnet the panel is located on

Gateway: Specify the IP address of the default router (Gateway) used for connecting attached devices to different networks.

Primary DNS: Specify the IP address of the Primary DNS Server for your network.

Secondary DNS: Specify the IP address of the Secondary DNS Server for your network.

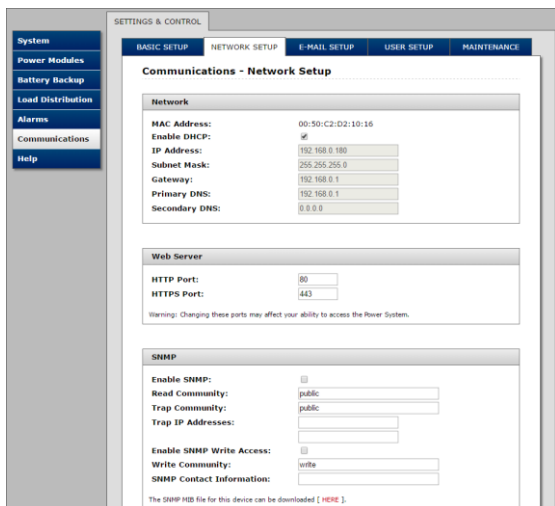

Web Server:

CAUTION:

Changing the web server port numbers may cause loss of communication with the panel

The following ports may be changed within a range of 1 to 65565, if required.

HTTP Port: This port is used for HTTP traffic between the panel and your browser. The default HTTP port is **80**, and if you change this the new HTTP Port number must be appended to the URL used to access the panel. (e.g. use URL **http://192.168.0.180:8000** for IP address **192.168.0.180**, port **8000**)

HTTPS Port: The HTTPS (HTTP Secure) protocol uses encrypted data transfer between web browsers and servers for higher security. The default HTTPS port is **443**. Append any changed HTTPS port to the end of the URL for the panel.

To access the panel through a secure HTTPS connection, use **https://** at the start of the units URL. (e.g. **https://192.168.0.180:8888** for IP address **192.168.0.180**, HTTPS port **8888**)

SNMP

Configure these settings if you would like to use SNMP based monitoring. SNMP (Simple Network Management Protocol) is an industry standard protocol for network management software. Enabling the SNMP function on the panel will allow standard SNMP management software to connect to the SNMP agent running on the panel and read real time system information such as bus voltage, and channel currents. The panel can send SNMP traps to the external management software when an alarm or fault occurs.

The information available from the SNMP agent is described in a MIB (Management Information Base) file, which can be downloaded from the link at the bottom of the SNMP box on this GUI page, or on the panels **Help** page. The unique panel MIB file must then be imported into your external SNMP management software.

Enable SNMP: Check this box to enable the SNMP agent.

SNMP Version: Sets the SNMP version (**v1/v2c**, **v3**, or **All**) supported by the SNMP agent. If **All** is selected, all SNMP versions will be supported simultaneously. The appropriate settings for the selected SNMP version will need to be configured.

Enable SNMP Write Access: Check this box to allow remote SNMP control of the system output and individual LDM output channels. If this box is unchecked, all information available from the SNMP agent will be read-only.

SNMP Contact Information: Assign contact information, such as an operator name and phone number for the panel, which can be read via SNMP queries. (This information is optional)

SNMPv1/v2c Settings:

Read Community: Enter the community string/password here for read-only SNMP access. The default read community string is “public”.

Write Community: Enter the community string/password here for read/write SNMP access. The default write community string is “write”.

NOTE:

The community strings should be changed to unique passwords before enabling SNMP, as the defaults are well known.

SNMPv3 Settings:

User Name: Enter the user name for SNMPv3 access.

Authentication Protocol: Select the SNMPv3 authentication protocol (**None, MD5, or SHA**).

Authentication Password: If an authentication protocol is selected, enter the authentication password.

Privacy Protocol: Select the SNMPv3 privacy protocol (**None, or AES**).

Privacy Password: If a privacy protocol is selected, enter the privacy password.

SNMP Trap Settings:

Trap Community: Enter the community string/password that is sent with all traps. Some trap receivers are able to filter on trap community.

Trap IP Addresses: Enter the IP addresses for up to two devices that will receive SNMP traps from the panel.

Select the **E-MAIL SETUP** page to configure all e-mail settings to enable automatic e-mail notifications directly from the unit. The information required for this is available from your Network Administrator, or Internet Service Provider (ISP).

The screenshot displays the ICT web interface for configuring email settings. The top left features the ICT logo and the slogan "The Power of Reliability". The top right identifies the device as a "Modular Power System" with details: "Modular Power Series 48V", "IP Address: 192.168.0.100", and "Firmware: v1.00". A navigation menu on the left includes "System", "Power Modules", "Battery Backup", "Load Distribution", "Alarms", "Communications", and "Help". The main content area is titled "SETTINGS & CONTROL" and has tabs for "BASIC SETUP", "NETWORK SETUP", "E-MAIL SETUP", "USER SETUP", and "MAINTENANCE". The "E-MAIL SETUP" tab is active, showing the "Communications - E-mail Setup" page. This page is divided into two sections: "E-mail" and "General E-mail Notifications".

E-mail Configuration:

- SMTP Server: smtp.gmail.com
- SMTP Port: 465
- SMTP Server requires SSL:
- Sender E-mail Address: example@gmail.com
- Recipient E-mail Addresses: example@gmail.com
- SMTP User Name: example
- SMTP Password:
- Minimum E-mail Interval: 1 minute(s)

Use commas to separate multiple Recipient E-mail Addresses.
Leave the SMTP User Name & Password blank if the SMTP Server does not require authentication.

General E-mail Notifications:

Send an E-mail Notification when:

- AC Input Power is lost:
- A Power Module failure occurs:
- A Module is offline:
- System Current Limit is triggered:
- Intelligent Controller Module reset:
- The Network Watchdog Triggers:

E-mail:

SMTP Server: Enter the name or the IP address of your SMTP server used for sending outgoing e-mail. (e.g. "smtp.gmail.com")

SMTP Port: Enter the port used by your SMTP server. (Normally 25)

SMTP Server requires SSL: Check this box if your SMTP server requires an encrypted SSL connection.

Sender E-mail Address: Enter an e-mail address that will appear as the sender for all e-mail notifications sent from the panel.

Recipient E-mail Addresses: Enter one or more e-mail addresses that are to receive all e-mail notifications from the panel. Use commas to separate multiple addresses. This field can also be used to send a text message notification to a phone; see the **Text Message Notifications** section for further information.

SMTP User Name: Enter a SMTP user name here, if required by your SMTP server. Leave this field blank if the server does not require authentication.

SMTP Password: Enter a SMTP password here, if required by your SMTP server. Leave this field blank if the server does not require authentication.

Minimum E-mail Interval: Specify a minimum interval required between e-mail notifications. (Default 1 minute, range 0 to 60 minutes) This time interval is used to prevent an un-intended flood of e-mail alarm notifications that could occur when an alarm limit is incorrectly configured, for example.

General E-mail Notifications:

Select these options to receive an e-mail when one or more of these events occurs:

AC Input Power is lost: Check this box to receive an e-mail notification when the ac input drops below a functional level.

Power Module Failure occurs: Check this box to receive an e-mail notification when any of the installed power modules stop functioning.

A Module is Offline: Check this box to be notified when a module loses communication with the ICM.

System Current Limit is triggered: Check this box to get a notification each time the system output current hits the maximum current limit value

Intelligent Controller Module reset: Check this box for notification of an ICM reset for any reason.

The Network Watchdog triggers: Check this box to receive an e-mail notification after the Network Watchdog triggers due to a loss of the network connection and the network has then come back online.

Select the **USER SETUP** tab to set up and configure the password for up to 10 users, with the ability to limit who has access to the panel settings. Click on the **Save Settings** button at the bottom of the page to save any password changes.

The unit has no password assigned by default, so an Administrator password should be assigned to your panel for improved security.

 **NOTE:**

Record your new password(s) for future access! If the Administrator password is lost the unit must be reset to return the password to the blank default setting, causing loss of all other user settings. See the **Password Reset** section for more details.

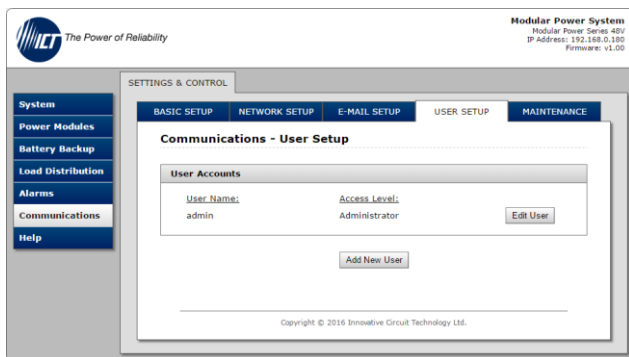

Select a User to Edit: Choose which of the user accounts to edit. Set the access level to be appropriate for the amount of control each user requires.

Administrator: This level has full access to the panel settings, and can set up users and change passwords (“admin” is the default user)

Control: User has read-only access to the panel, but can enable or disable the outputs, and change some of the basic settings.

View-Only: User can only view status, cannot change any settings

New Password: Use these fields to change the password of the selected user.

New Password: Enter the new password for the chosen user.

Confirm New Password: Re-enter the new password to confirm the entry.

Confirm Changes: Enter the current **Administrator Password** to confirm the new password changes, prior to saving the settings.

Use the **MAINTENANCE** tab to reset the panel (soft reset), restore the panel default settings, or send a test e-mail to verify e-mail functionality.

Reset Intelligent Controller Module: Clicking the **Reset** button will restart the controller. The LDM channel output states will be restored according to the **Output State after Panel Reset** setting for each output on the **Output Setup** page. All other settings are maintained during the reset.

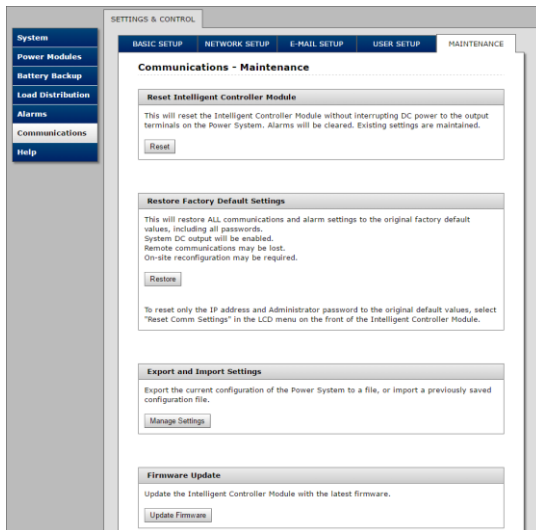

Restore Factory Default Settings: Clicking the Restore button will restore **ALL** settings to the original factory default values, including the user passwords. To only restore the network settings and passwords see the **Password Reset** section. (This feature is only available to the system Administrator).

Note: Restoring the unit to Factory Default settings may cause loss of network communications due to loss of custom changes to any network settings

To reset only the IP address and Administrator password to the original default values, select **Reset Comm Settings** in the graphic display menu on the front of the Intelligent Controller Module.

Export and Import Settings: The **Manage Settings** button will take you to the Export and Import Settings page, where you may export all the system settings (other than the Administrator password, Network and Web Server settings) to an encrypted **.cfg** file on the local computer. Use the **Import Settings** section on other systems to locate this file and then import it to any other MPS you are logged in to, greatly simplifying the configuration of multiple identical units.

Firmware Update: Download the latest MPS Ultra firmware file from the ICT website (ict-power.com) to your local computer. De-compress this **.cry** file then press the **Update Firmware** button, and link to this file. Update the firmware on the power system control module by clicking the **Update Now** button. Note that the system settings will not be changed. Do not remove AC power during the update process!

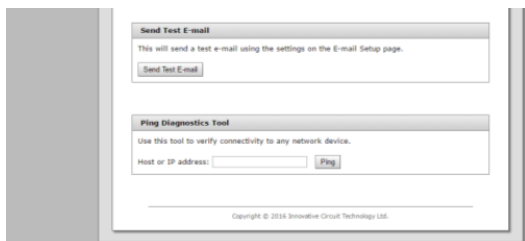

Send Test E-mail: Click the **Send Test E-mail** button to send a test e-mail to the listed e-mail recipients using the e-mail settings on the **E-mail Setup** page.

Ping Diagnostics Tool: Use this feature to verify connectivity of any network connected device. Enter the hostname or IP address of the target device, and then click the **Ping** button to check if the device is active.

Router Configuration

Use this section to help you set up your MPS Ultra system with remote Internet access when it is located behind a router.

A router allows multiple PC's to share a single Internet connection, and must be configured correctly to forward incoming remote data to the local IP address of your panel.

Example configuration using a Linksys WRT54G router: (others will be similar)

1. Log into your router and go to the port forwarding screen. In the example Linksys WRT54G router this is located in the Applications and

Gaming tab. The location of the port forwarding fields may be different on your particular router. (consult the router manual for instructions)

2. Configure HTTP forwarding:
 - a. Enter a unique name in the **Application** field
 - b. Enter the HTTP port number that the panel is using in the **Start** and **End** fields. The default HTTP port for the panel is **80**.
 - c. Select **Both** under **Protocol** (TCP and UDP)
 - d. Enter the local IP address of the panel (e.g. 192.168.0.180) in the **IP address** field. (see step 2 of the **Operation (Network GUI)** section to verify the panel IP address)
 - e. Check the **Enable** box, and then click on **Save Settings**

 **NOTE:**

Many ISP's block access to port 80, so if your ISP does block this port you must change the HTTP port the panel uses from 80 to something else, such as 8000. (Valid port numbers are in the range of 1 to 65535) See the **Network Setup** section for information on assigning new network ports.

You must also change the panel's HTTP port from 80 if your local network has another device (such as a panel, or web server) already using port 80.

3. Configure HTTPS forwarding by repeating steps 2a to 2e with the HTTPS port number that the panel is using. The default HTTPS port number is **443**.

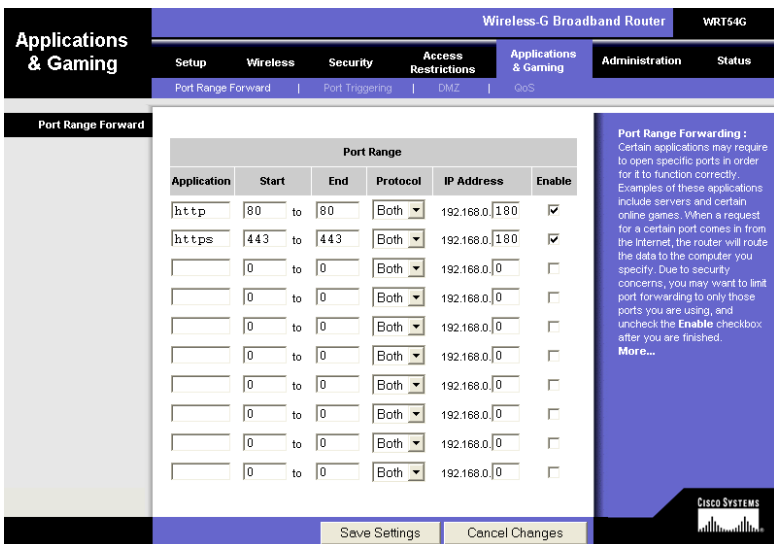

The screenshot shows the 'Port Range Forward' configuration screen on a Cisco WRT54G router. The interface includes a navigation menu at the top with tabs for Setup, Wireless, Security, Access Restrictions, Applications & Gaming, Administration, and Status. The 'Applications & Gaming' tab is active, and the 'Port Range Forward' sub-tab is selected. The main area contains a table for configuring port forwarding rules. The table has columns for Application, Start, End, Protocol, IP Address, and Enable. Two rules are currently configured: one for 'http' on port 80 and one for 'https' on port 443, both using protocol 'Both' and IP address '192.168.0.180', and both are checked as 'Enabled'. Below the table are 'Save Settings' and 'Cancel Changes' buttons. A help sidebar on the right explains 'Port Range Forwarding' and provides examples of applications like servers and online games. The Cisco Systems logo is visible in the bottom right corner of the interface.

Port Range					
Application	Start	End	Protocol	IP Address	Enable
http	80	to 80	Both	192.168.0.180	<input checked="" type="checkbox"/>
https	443	to 443	Both	192.168.0.180	<input checked="" type="checkbox"/>
	0	to 0	Both	192.168.0.0	<input type="checkbox"/>
	0	to 0	Both	192.168.0.0	<input type="checkbox"/>
	0	to 0	Both	192.168.0.0	<input type="checkbox"/>
	0	to 0	Both	192.168.0.0	<input type="checkbox"/>
	0	to 0	Both	192.168.0.0	<input type="checkbox"/>
	0	to 0	Both	192.168.0.0	<input type="checkbox"/>
	0	to 0	Both	192.168.0.0	<input type="checkbox"/>
	0	to 0	Both	192.168.0.0	<input type="checkbox"/>

Router Port Forwarding Screen

- Determine the WAN IP address of your router assigned by the ISP. With the example router this information is on the **Status** tab, listed as **IP Address**.

 **NOTE:**

When using a dynamic IP address the router's WAN IP address may change from time to time without warning, depending on your ISP. In this case you should obtain a Static IP address from your ISP (it will not change) which will ensure more predictable access to the panel from a remote location. If a static IP address is not available you can use a Dynamic DNS service such as Dyn (www.dyn.com) to provide a stable address for the router.

- To access the panel over the internet type the WAN IP address of the router in the location/address field of your browser, followed by a colon and the HTTP port number the panel is using. (e.g. **http://209.123.10.33:8000** for a router address **209.123.10.33**, port **8000**)

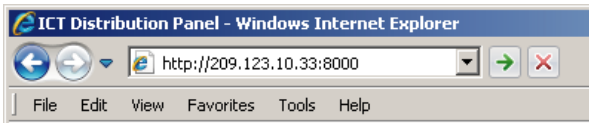

Panel Access with Router Address

Text Message Notifications

The panel can send alarm notifications as text messages to a cell phone by configuring the alarm e-mails to be sent to your mobile phone service provider. On the **E-mail Setup** page of the web based utility enter the address of your phone in the **Recipient E-mail Address** field.

Example with an AT&T phone: enter the recipient address **cellnumber@txt.att.net**, replacing **cellnumber** with your 10 digit cell phone number.

Cell address formats for some common North American mobile phone providers:

AT&T	<i>cellnumber@txt.att.net</i>
Verizon	<i>cellnumber@vtext.com</i>
Sprint	<i>cellnumber@messaging.sprintpcs.com</i>
T-Mobile	<i>cellnumber@tmomail.net</i>
Virgin Mobile	<i>cellnumber@vmobl.com</i>
Nextel	<i>cellnumber@messaging.nextel.com</i>

Bell Mobility	<code>cellnumber@txt.bell.ca</code>
Rogers	<code>cellnumber@pcs.rogers.com</code>
Telus	<code>cellnumber@msg.telus.com</code>
Virgin Mobile (Can)	<code>cellnumber@vmobile.ca</code>

Troubleshooting Network Communications

I am unable to access the web-based configuration utility:

- Check that you are using the correct IP address for the system by downloading and running the **ICT IP Address Discovery tool** <http://www.ict-power.com/tools-utilities/>
- Check the network cable connections to the panel and the network
- Ensure the network card settings on your computer are configured for accessing the IP address of the MPS. To access a panel with the default IP address of 192.168.0.180 the typical network settings for your computer are:
 - IP Address: 192.168.0.180
 - Subnet Mask: 255.255.255.0
 - Gateway: 192.168.0.1
- If the HTTP port of the panel has been changed, you must append the new port number to the URL used to access the panel. (See the **Network Setup** section) See the **Password Reset** section for details on how to reset the port number to the factory default value.
- If your network switch allows you to manually configure port speed and duplex settings, turn-on “**Auto Negotiation**” for the switch port that the panel is connected to.

I forgot my password:

- See the Password Reset section of the manual

I am not receiving e-mails from the panel:

- Verify that the **Send-E-mail** checkboxes are ticked for any alarm conditions for which you wish to receive e-mail notifications.
- Verify your e-mail settings by going to the **Communications/Maintenance** page on the unit’s web GUI and clicking on the **Send Test E-mail** button, to send a test message to your designated recipient addresses. The **Send Test E-mail** box will show an error message if the system is unable to send the e-mail.

- Check on the **Communications/E-mail Setup** page and ensure the **SMTP Server** field is the correct address for your e-mail provider, and the **SMTP Port** is correct. (Port should be 25 for most servers)
- If your SMTP server requires SSL encryption, ensure the **SMTP Server requires SSL** checkbox is ticked. Otherwise leave blank.
- If your SMTP server requires authentication ensure that the **SMTP User Name** and **SMTP Password** fields are correctly entered.

STATUS INDICATORS AND ALARMS

The status of the MPS Ultra system generally is indicated on the front graphic display module on units equipped with the ICM, or via the network GUI on remotely monitored units. Green “POWER” and red “FAULT” LED’s on the power modules, along with the Form-C alarm contacts on the back panel indicate the core status of power system, even on non-ICM equipped units.

There is an option on the Setup page in the GUI for most alarms to make a selection to have the system send an Email to designated addresses for remote notification.

All alarms and warnings will be displayed on the ICM front graphic display, and entered in the Alarm History log. (Most recent 20 alarms listed)

Alarms generally reset automatically when the trigger condition is removed. Major alarms such as a Module DC Output Failure or Module Configuration Error require that the module be temporarily removed to cycle input power and clear the fault.

Power Module Alarms:

Alarm Condition	Trigger Condition	Module Output ¹	Red LED	Green LED	Alarm Relay	Send Email ²
Power Failure	Loss of AC power to module	Disabled	Off	Off	Active	Yes
Module Operating	Normal operation	On	Off	On	No	-
Configuration Error	Different voltage modules installed	Off	On	Off	Active	Yes
Current Limit (Warning)	Output current approaches within	On	Off	On	No	-

¹ Other power modules are not affected when one module has its output disabled

² Email notifications only sent if enabled in the unit’s Network GUI Email Setup page, and either ac or dc power is available for the system to be operational

Alarm Condition	Trigger Condition	Module Output ¹	Red LED	Green LED	Alarm Relay	Send Email ²
only, display will flash)	1A of the max current limit setting					
Fan Failure	Fan is not operating to spec	On	Off	On	No	Yes
Manual Disable	Output switched off by ICM or GUI	Disabled	Blink	Off	No	-
Module Removal	Module connections open	Disabled	On	Off	No	-
PFC Shutdown	Internal bus voltage out of range	Disabled	On	Off	Active	Yes
Module Fault	Internal aux voltages out of range	Disabled	On	Off	Active	Yes
Over Temp Shutdown	Internal temp too high	Disabled	On	Off	Active	Yes
DC Output Failure	Output above set point (Manually re-enable dc output to reset)	Disabled	On	Off	Active	Yes

Battery Management Module (BMMD) Alarms:

Alarm Condition	Trigger Condition	LVD Contactor	ICM Required	Alarm Relay	Send Email ³
Module Power Failure	Loss of AC, and battery disconnected	Open	No	-	Yes
No Alarms	Normal Operation	Closed	No	No	-
Battery Low SOC	SOC drops below Low SOC setting	Closed	Yes	Active ³	Yes
Battery Overcurrent	Battery I rises above OC setting for 10s	Closed	Yes	Active ⁴	Yes
Circuit Breaker Open	Circuit breaker trips or manually opened	Open	Yes	Active ⁴	Yes
Battery Over Temperature	Optional TMP probe temp >50C for 5s	Open	Yes	Active ⁴	Yes
LVD	Battery V at LVD or Overvoltage setting	Open	No	Active	Yes
Configuration Error	Mixed polarity modules, or installed in slot 1, 2, 5, or 6	Open	No	Active	Yes

Load Distribution Module (LDM) Alarms:

Alarm Condition	Trigger Condition	Output Relays	ICM Required	Alarm Relay	Send Email ³
Module Power Failure	Loss of AC and DC bus connection	Open	No	-	Yes
No Alarms	Normal Operation, outputs enabled	Closed	No	No	-
Circuit Breaker Open	Circuit breaker opened or tripped	Closed	Yes	Active ⁴	Yes
Output Undercurrent	Output current drops below setting for 5s	Closed	Yes	Active ⁴	Yes

³ Contact active only if alarm enabled in the Network GUI module Setup page

Alarm Condition	Trigger Condition	Output Relays	ICM Required	Alarm Relay	Send Email ³
Output Overcurrent	Output current rises above setting for 5s	Closed	Yes	Active ⁴	Yes
Configuration Error	Mixed polarity modules, or installed in slot 1, 2, 5, or 6	No change	Yes	Active ⁴	Yes
Load Shedding	V drops below Load Shed setting for 30s	Open	Yes	Active ⁴	Yes
Output Manually Disabled	Output manually disabled via ICM or GUI page	Open	Yes	-	-

Intelligent Control Module (ICM) Alarms:

Alarm Condition	Trigger Condition	Alarm Relay	Send Email ³
Alarm Input	Contact open or close on any Alarm input 1 to 4	Active (if set up on Alarm Input page)	Yes
AC Input Failure	AC input falls below 90Vac	Active	Yes
System Overcurrent	Total output current on System is >150Adc for 20s	Active	Yes
System Current Limit	ALL power modules in system at their current or power limit for 15s	Active	Yes
Communication Bus Error	Internal communication bus error condition	Active	-

PRODUCT SPECIFICATIONS:

AC Input Nominal Rating:	120/240Vac 50/60Hz
AC Input Operating Range:	108 to 264Vac
AC Input Maximum Range:	100 to 280Vac
Input Power Factor:	0.99 typ (120Vac input)
Efficiency (typical):	90%
Output V Line Regulation:	+/- 0.1%

	Power System	24V Module	48V Module
Output Voltage ⁴ (Nominal Battery float Voltage) (+/- 0.5%). Adjustable.	Set by Power Modules installed	27.6	55.2V
Max Current Limit (+5%, -0%)	150A _{dc}	28A	14A
Continuous Current Rating	150A _{dc}	25A	12.5A
Output Power (max)	5600W @48V	700W	700W
Output Noise (max mV _{rms})	-	30mV _{rms}	60mV _{rms}
Output V Load Regulation (over full load range at nominal output voltage)		1.7%	1.2%
Input Current (max at 120Vac)	32 Amps rms (with 2800W system output)	6.6A _{rms}	6.6A _{rms}
BMMD Max Battery Current (per input)	100A	-	-
BMMD Max total Battery Current through LVD	150A	-	-
BMMD LVD Threshold V (Default)	-	23.0V	46.0V
BMM LVD Reconnect V (Default setting)	-	25V	50V
BMMD idle DC Power Draw ⁵	<1W	-	-
LDM Max Load per Output (continuous)	-	20A	20A

Output Grounding:

Power Modules are floating, may be connected with Positive or Negative ground

Alarm Output:

Form-C contact, 0.5A
60V_{dc} max

DC Connectors: (Output, Battery)

Bus Bar, 5/16" bolt hole

⁴ Actual Operating point may be lower due to battery charge requirement

⁵ AC mains power off; backup battery connected; LVD open

Load Dist Module (LDM) Connectors:	8 terminal cage clamp style, 22-12AWG, 0.51Nm max torque
Alarm Output Connector:	3 pin removable plug, cage clamp type 16 –24 AWG
Alarm input, Bat temp sense Connector:	7 pin removable plug, cage clamp type 16 –24 AWG
Operating Temperature Range:	-30C to +60°C ⁶
Storage Temperature Range:	-40 to +70°C
Humidity: (Operating)	10 – 90% (non-condensing)
(Storage)	5 – 95% (non-condensing)
Cooling:	Load controlled fan on power modules
Regulatory Compliance:	UL/CSA60950-1, ICES-003, FCC Part 15/B , EN 61000-6-2 and EN 61000-6-3
Network Communication:	RJ45 10/100-T port (IPv4, HTTP, HTTPS, SMTP, DNS, TCP, UDP, ICMP, DHCP, ARP, SNMP, Sntp Protocols)
Network Security:	Password protection, SSL encryption for HTTPS and SMTP (TLS 1.0)
Height:	3.5" / 89 mm
Width:	19" / 483 mm
Depth (outside):	15.7" / 398 mm

⁶ De-rate output 2% per °C above 50°C

Weight (without Power Modules):

30 lbs / 13.6 kg

EMC Note: This equipment has been tested and found to comply with the limits for a Class B digital device, pursuant to part 15 of the FCC Rules and ICES 003. These limits are designed to provide reasonable protection against harmful interference in a residential installation. This equipment generates uses and can radiate radio frequency energy and, if not installed and used in accordance with the instructions, may cause harmful interference to radio communications. However, there is no guarantee that interference will not occur in a particular installation. If this equipment does cause harmful interference to radio or television reception, which can be determined by turning the equipment off and on, the user is encouraged to try to correct the interference by one or more of the following measures:

- Reorient or relocate the receiving antenna.
- Increase the separation between the equipment and receiver.
- Connect the equipment into an outlet on a circuit different from that to which the receiver is connected.
- Consult the dealer or an experienced RF technician for help.

Caution: Changes or modifications to this equipment not expressly approved by ICT Ltd. could void the user's authority to operate the equipment.

ICT LIMITED WARRANTY

ICT Limited Warranty is only intended for the benefit of the original Purchaser of this product. This Warranty is not transferable or assignable without the prior written permission of ICT. ICT's sole obligation and liability under this warranty is limited to either repairing or replacing defective products at the sole discretion of ICT. When repairing or replacing the products, ICT may use products or parts that are new, equivalent to new or re-conditioned. Parts repaired or replaced during the warranty period will be under warranty for the remainder of the warranty period.

The warranty period on ICT products purchased new from ICT is two years. The warranty period for a repaired product or part thereof is ninety (90) days or the remainder of the unexpired term of the new product warranty period, whichever is greater. Repair or replacement of a defective product or part does not extend the original warranty coverage period.

No claim will be accepted unless written notice of the claim is received by ICT in accordance with ICT's Return Material Authorization (RMA) procedure, as soon as reasonably possible after the defect is discovered. A valid product serial number must be provided with the RMA claim to prove eligibility. The RMA form is available on the ICT website at www.ict-power.com/support/warranty-repair/.

The Purchaser shall at their own risk and cost return the defective product to ICT's factory or designated repair center once an RMA is issued by ICT. Return of the products to the customer after repair is completed shall be prepaid by ICT unless otherwise mutually agreed between the parties. Products shipped to ICT which have incurred freight damage will not be covered by this Warranty and any repairs or replacement parts, components or products needed will be invoiced in the full current price amount and returned freight collect to Purchaser. It is the Purchaser's responsibility to check the product upon receipt for any damage during shipping and to contact the carrier or shipper regarding such damage. Product that is returned as defective, which is determined to operate within published specifications will be returned to the Purchaser freight collect.

Warranty commences on the date the product is shipped from the ICT manufacturing facility, or in the case of purchase through an authorized ICT reseller, not more than ninety (90) days after original shipment of this product by ICT.

ICT assigns to Purchaser any warranties which are made by manufacturers and suppliers of components of, or accessories for, the ICT product and which are assignable. ICT makes no representations as to the effectiveness or extent of such warranties, assumes no responsibility for any matters which may be warranted by such manufacturers or suppliers and extends no additional coverage under this Warranty to such components or accessories.

In no event shall ICT be liable for any special, indirect or consequential damages such as, but not limited to, loss of use, business or goodwill, loss of revenue, or loss of profits, which may result, either directly or indirectly, from defects in products provided by ICT.

This Warranty will be void if the product has been subjected to misuse, neglect, accident, exposure to environmental conditions not conforming to the products' limits of operation, improper installation or maintenance, improper use of an electrical source, defects caused by sharp items or by impact pressure, a force

majeure event, has been modified or repaired by anyone other than ICT or its authorized representative, has been subjected to unreasonable physical, thermal or electrical stress, improper maintenance, or causes external to the unit including but not limited to general environmental conditions such as rust, corrosive atmospheres, sustained temperatures outside the specified operating range of the equipment, exposure to power surges and/or electrical surges, improper grounding, mould or dust, animal or insect damage, water damage or immersion in liquid of any kind, or if the serial number has been altered, defaced, or removed.

ICT does not control the installation and use of any ICT product. Accordingly, it is understood this does not constitute a warranty of performance or a warranty of fitness for a particular purpose.

This Warranty represents the entire agreement between ICT and Purchaser with respect to the subject matter herein and supersedes all prior verbal or written communications, representations, understandings or agreements relating to this subject.

INNOVATIVE CIRCUIT TECHNOLOGY LTD.
26921 Gloucester Way
Langley, British Columbia, Canada V4W 3Y3
T 604.856.6303 F 604.856.6365 www.ict-power.com